

Coastal Industries Inc.

FAX NO.
(904) 641-1697

P.O BOX 16091
JACKSONVILLE, FLORIDA 32246

TELEPHONE NO.
(904) 642-3970

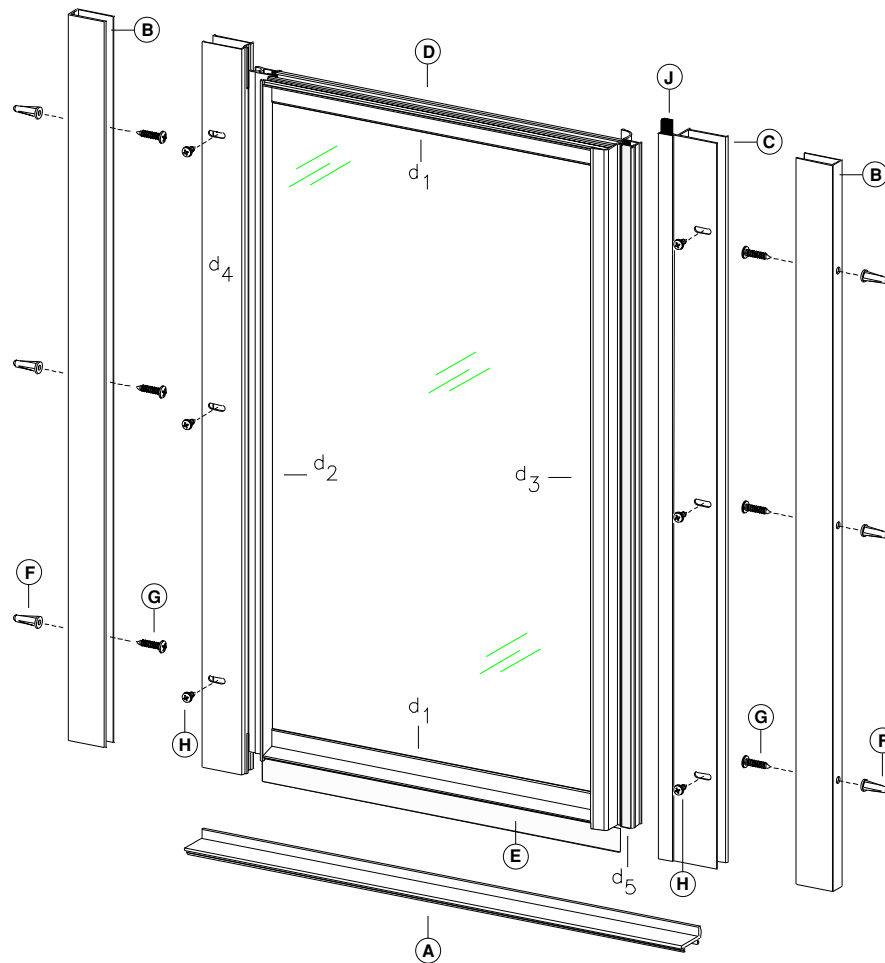

TRIDENT CONTINUOUS HINGE UNIT
(EXPLODE VIEW - INSIDE OF UNIT LOOKING OUT)

KEY LETTER	PART NUMBER	DESCRIPTION	QUANTITY
A	98	SILL.....	1
B	147	EXPANDER JAMB.....	2
C	156	STRIKE JAMB.....	1
D	----	<u>DOOR ASSEMBLY</u>	1
d1	227	Door Rails.....	2
d2	154	Door Hinge Stile.....	1
d3	226	Door Strike Stile.....	1
d4	155	Door Hinge Jamb.....	1
d5	98-42	Door Magnet.....	1
d6	c173c	Glazing Vinyl (not shown).....	
d7	6112fhs1	Door Assembly Screw (not shown).....	4
d8	cp156	Door Assembly Hinge Pin (not shown)....	2
E	c176g	VINYL SWEEP.....	1
F	1329	PLASTIC SCREW ANCHORS.....	6
G	8112	INSTALLATION SCREWS.....	6
H	638phpt	ADJUSTMENT SCREWS.....	6
J	98-42	MAGNET.....	1

INSTALLATION INSTRUCTIONS

1. Lay entire contents on floor to understand design concept of the product.
2. Measure the opening width at curb level (see fig.1), then trim Sill (A) to 1/16" less than measurement obtained.
3. Turn Sill (A) over and apply a bead of caulking the full length of its underside. With high lip to the exterior, position Sill at center of shower curb.
4. Position Wall Jambs (B) atop ends of Sill (A) and up against shower walls. Use a level to plumb the Wall Jambs, then make a pencil mark on the shower walls thru each of the six(6) installation holes (three per jamb). Remove Wall Jambs and lightly center punch installation hole locations.

Note:

Use a 3/16" masonry bit when drilling thru ceramic tile, marble or any masonry type surface; otherwise use a standard 1/8" bit.

Drill 1-1/2" deep installation holes and insert Plastic Screw Anchors (F). Reposition Wall Jambs as before and secure to shower walls using Installation Screws (G).

5. Insert Magnet Strip (J) into the Strike Jamb's (C) magnet receiver (see fig.2). Magnet groove must be positioned as shown in order for door to close properly. At this time, determine from which side you wish the door to hinge (*left or right side, your choice*), then slide the Strike Jamb (C) over the strike side Wall Jamb. Adjustment slots must face toward interior of enclosure (see fig.2).

6. Trim Vinyl Sweep (H) to length as shown in figure 3 and insert it into the Door Assembly's bottom Vinyl Sweep slot as shown in figure 4.

7. Lift the Door Assembly (D) onto the curb and slide the Hinge Jamb (d4) over the remaining Wall Jamb. Let magnet strips on Door Strike Stile (d3) and the Strike Jamb (C) meet (see fig 5). Slide the Door Assembly and the Strike Jamb to the desired adjustment (see fig 5). Now check to make sure that you have a parallel alignment between the bottom of Door Assembly and the Sill (see figure 6). When satisfied, secure unit to Wall Jambs using the six(6) Adjustment Screws (H) provided. Recheck to make sure that Door Assembly is still parallel to sill. If it is not, readjust as required using slots on (d4 and C).

8. From **outside** of unit, seal the Wall Jambs and the Sill with a clear silicone or rubberized sealant to guarantee a no leak installation.

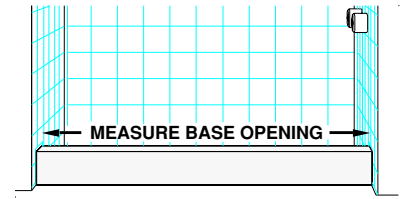

fig.1

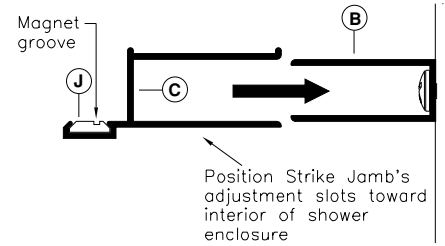

fig.2

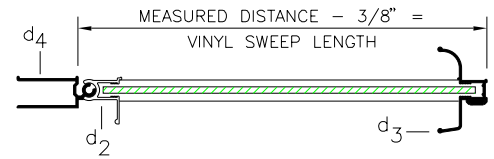

fig.3

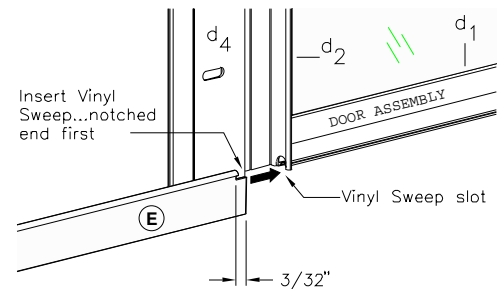

fig.4

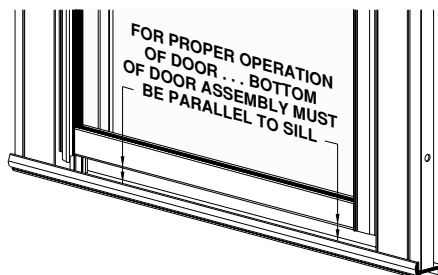

fig.6

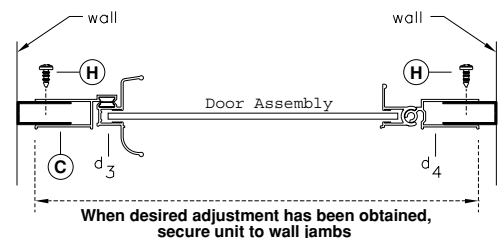
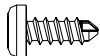

fig.5

BAGGIE CODE NO. TCH
Installation Hardware
(Trident Hinged Door) brite



1329 (6 pcs)
Plastic Wall Anchor



638PHPT (6 pcs)
Adjustment Screw
#6x3/8" Pan Head Screw



8112 (6 pcs)
Wall Jamb Installation Screw
#8x1 1/2" Phillips Head Screw